



**KATALOG
PROIZVODA ZA
FARMERE**



 **kurtsan**

ELEKTROTEHNIKA

arangül® SER DRIP

"ITC Zenica" d.o.o. ZENICA

Zmaja od Bosne bb, 72000 Zenica

tel. +387 32 246 117

fax. +387 32 405 970

mob.+387 61/280-266

mob.ser.+387 62/343-137

poljoprivreda@itc.ba

www.itc.ba

FB: ITC Zenica

PC Poljoprivreda



ITC Zenica d.o.o.

Zmaja od Bosne bb, 72000 Zenica

ID broj: 4218146790003

tel.+387 32 441 200 fax.+387 32 405 970

mob.prodaja +387 61/280-266

mob.servis +387 62/343-137

f.b / ITC Zenica d.o.o.

poljoprivreda@itc.ba / www.itc.ba



MLJEKOVOD

Projekti po sistemu ključ u ruke

Planiranje - Produkcija - Montaža - Post-prodajna podrška

Farma muznih krava - Pjano Mirsad, Donja Vogošća
SARAJEVO



Muža na farmi Mirsada Pjanića

OPREMA, TEHNOLOGIJA, KONSTRUKCIJA, MONTAŽA I GRATIS OBUKA "ITC Zenica" d.o.o.



Projekti po sistemu ključ u ruke

Planiranje - Produkcija - Montaža - Post-prodajna podrška

Farma muznih koza BINGO TUZLA

FARMA MUZNIH KOZA TUZLA

OPREMA I TEHNOLOGIJA



AUTOMATSKO IZMUZIŠTE ZA KOZE SA BRZIM IZLAZIMA 2*12



00387 35 368 996

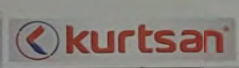

0090 212 605 09 09 - 00381 21 31 19 60



00387 32 441 200

INSTALACIJA 2015. godine, TUZLA



Prva muža na farmi BINGO

OPREMA, TEHNOLOGIJA, KONSTRUKCIJA,
MONTAŽA I OBUKA "KURTSAN" ISTANBUL &
"Kurtsan Agri" & "ITC Zenica" d.o.o.



Projekti po sistemu ključ u ruke

Planiranje - Produkcija - Montaža - Post-prodajna podrška

Farma muznih koza BINGO TUZLA



Projekti po sistemu ključ u ruke

Planiranje - Produkcija - Montaža - Post-prodajna podrška

Farma muznih koza EURO-ASFALT Sarajevo



OPREMA, TEHNOLOGIJA,
KONSTRUKCIJA, MONTAŽA I
OBUKA "ITC Zenica" d.o.o.



Projekti po sistemu ključ u ruke

Planiranje - Produkcija - Montaža - Post-prodajna podrška

Farma muznih koza EURO-ASFALT Sarajevo





MUZILICE

MLJEKOSABIRNIK 180CC - SISNE GUME-STANDARD GUMA

POKRETNE MUZILICE - SUVA VAKUUM PUMPA

KM01031		CYK POKRETNNA MUZILICA ZA JEDNU KRAVU SA JEDNOM KANTOM	
		VAKUUM PUMPA	SUHA
		KAPACITET PUMPE	185LT/H
		PULSATOR	1KOM-MEHANIČKI
		MLJEKOSABIRNIK	1 KOM / 180CC
		SISNE GUME	GUMA
		KANTA	1KOM/20 l, PROHROM
		VAKUUM TANK	UNUTAR CIJEVI ŠASIJE
		ELEKTRIČNI MOTOR	220V-50HZ, 3/4HP MONOFAZNI
DIMENZIJE/TEŽINA	55X70X90CM / 47,00KG		
KM02071		CYK POKRETNNA MUZILICA ZA DVIJE KRAVE SA JEDNOM KANTOM	
		VAKUUM PUMPA	SUHA
		KAPACITET PUMPE	185LT/H
		PULSATOR	2KOM/MEHANIČKI
		MLJEKOSABIRNIK	2KOM/180cc
		SISNE GUME	GUMA
		KANTA	1KOM/40l, PROHROM
		VAKUUM TANK	UNUTAR CIJEVI ŠASIJE
		ELEKTRIČNI MOTOR	220V-50HZ, 3/4HP MONOFAZNI
DIMENZIJE/TEŽINA	55X70X100CM / 58,00KG		
KM01011		POKRETNNA MUZILICA ZA JEDNU KRAVU SA JEDNOM KANTOM	
		VAKUUM PUMPA	SUHA
		KAPACITET PUMPE	185LT/H
		PULSATOR	1KOM/MEHANIČKI
		MLJEKOSABIRNIK	1 KOM/ 180CC
		SISNE GUME	GUMA
		KANTA	1KOM/30l, PROHROM
		VAKUUM TANK	TOPLOCINČANI
		ELEKTRIČNI MOTOR	220V-50HZ, 3/4HP MONOFAZNI
DIMENZIJE/TEŽINA	60X90X100CM / 60,00KG		
KM01024		CYK POKRETNNA MUZILICA ZA JEDNU KRAVU SA JEDNOM KANTOM	
		VAKUUM PUMPA	SUHA
		KAPACITET PUMPE	185LT/H
		PULSATOR	1KOM-MEHANIČKI
		MLJEKOSABIRNIK	1 PKOM / 180CC
		SISNE GUME	GUMA
		KANTA	1KOM/30 l, POLIETILEN /SILIKON
		VAKUUM TANK	UNUTAR CIJEVI ŠASIJE
		ELEKTRIČNI MOTOR	220V-50HZ, 3/4HP MONOFAZNI
DIMENZIJE/TEŽINA	55X70X90CM / 47,00KG		

**MUZILICE****MLJEKOSABIRNIK 180CC - SISNE GUME-STANDARD GUMA****POKRETNE MUZILICE-ULJNA VAKUUM PUMPA**

KM01041		CYK POKRETNNA MUZILICA ZA JEDNU KRAVU SA JEDNOM KANTOM	
		VAKUUM PUMPA	ULJNA
		KAPACITET PUMPE	200LT/H
		PULSATOR	1KOM/MEHANIČKI
		MLJEKOSABIRNIK/SISNE GUME	1KOM/180cc/SILIKON GUME
		KANTA	1KOM/30l, PROHROM
		VAKUUM TANK	UNUTAR CIJEVI ŠASIJE
		ELEKTRIČNI MOTOR	220V-50HZ, 3/4HP MONOFAZNI
DIMENZIJE/TEŽINA	55X70X90CM / 47,00KG		
KM02081		CYK POKRETNNA MUZILICA ZA DVIJE KRAVE SA JEDNOM KANTOM	
		VAKUUM PUMPA	ULJNA
		KAPACITET PUMPE	200LT/H
		PULSATOR	2KOM/MEHANIČKI
		MLJEKOSABIRNIK/SISNE GUME	2KOM/180cc/SILIKON GUME
		KANTA	1KOM/40l, PROHROM
		VAKUUM TANK	UNUTAR CIJEVI ŠASIJE
		ELEKTRIČNI MOTOR	220V-50HZ, 3/4HP MONOFAZNI
DIMENZIJE/TEŽINA	55X70X100CM / 58,00KG		
KM01021		POKRETNNA MUZILICA ZA JEDNU KRAVU SA JEDNOM KANTOM	
		VAKUUM PUMPA	ULJNA
		KAPACITET PUMPE	200LT/H
		PULSATOR	1KOM/MEHANIČKI
		MLJEKOSABIRNIK	1KOM/180CC
		SISNE GUME	GUMA
		KANTA	1KOM/30l, PROHROM
		VAKUUM TANKA	TOPLOCINČANI
ELEKTRIČNI MOTOR	220V-50HZ, 3/4HP MONOFAZNI		
DIMENZIJE/TEŽINA	60X90X100CM / 60,00KG		
KM02041		POKRETNNA MUZILICA ZA DVIJE KRAVE SA JEDNOM KANTOM	
		VAKUUM PUMPA	ULJNA
		KAPACITET PUMPE	200LT/H
		PULSATOR	2KOM/MEHANIČKI
		MLJEKOSABIRNIK	2KOM/180CC
		SISNE GUME	GUMA
		KANTA	1KOM/40l, PROHROM
		VAKUUM TANK	TOPLOCINČANI
ELEKTRIČNI MOTOR	220V-50HZ, 3/4HP MONOFAZNI		
DIMENZIJE/TEŽINA	60X90X110CM / 70,00KG		
KM03041		POKRETNNA MUZILICA ZA DVIJE KRAVE SA DVIJE KANTE	
		VAKUUM PUMPA	ULJNA
		KAPACITET PUMPE	200LT/H
		PULSATOR	2KOM/MEHANIČKI
		MLJEKOSABIRNIK	2KOM/180CC
		SISNE GUME	GUMA
		KANTA	2KOM/30l, PROHROM
		VAKUUM TANK	TOPLOCINČANI
ELEKTRIČNI MOTOR	220V-50HZ, 3/4HP MONOFAZNI		
DIMENZIJE/TEŽINA	80X100X110CM / 80,00KG		

**MUZILICE****MLJEKOSABIRNIK 180CC - SISNE GUME-STANDARD GUMA****POKRETNE MUZILICE-ULJNA VAKUUM PUMPA**

KM03010		POKRETNA MUZILICA ZA JEDNU KRAVU SA JEDNOM KANTOM ELEKTRIČNIM MOTOROM I MOTOROM NA BENZIN	
		VAKUUM PUMPA	ULJANA
		KAPACITET PUMPE	200LT/H
		PULSATOR	1KOM/MEHANIČKI
		MLEKOSABIRNIK	1KOM/180CC
		SISNE GUME	GUMA
		KANTA	1KOM/30I, PROHRROM
		VAKUUM TANK	TOPLOCINČANI
		ELEKTRIČNI MOTOR	220V-50HZ, 3/4HP MONOFAZNI
		BENZINSKI MOTOR	HONDA GX120
		DIMENZIJE/TEŽINA	60X90X100CM / 90,00KG
KM02061		POKRETNA MUZILICA ZA DVIJE KRAVE SA JEDNOM KANTOM ELEKTRIČNIM MOTOROM I MOTOROM NA BENZIN	
		VAKUUM PUMPA	ULJANA
		KAPACITET PUMPE	200LT/H
		PULSATOR	2KOM/MEHANIČKI
		MLEKOSABIRNIK	2KOM/180CC
		SISNE GUME	GUMA
		KANTA	1KOM/40I, PROHRROM
		VAKUUM TANK	TOPLOCINČANI
		ELEKTRIČNI MOTOR	220V-50HZ, 3/4HP MONOFAZNI
		BENZINSKI MOTOR	HONDA GX120
		DIMENZIJE/TEŽINA	60X90X110CM / 90,00KG
KM03061		POKRETNA MUZILICA ZA DVE KRAVE SA DVIJE KANTE ELEKTRIČNIM MOTOROM I MOTOROM NA BENZIN	
		VAKUUM PUMPA	ULJANA
		KAPACITET PUMPE	200LT/H
		PULSATOR	2KOM/MEHANIČKI
		MLEKOSABIRNIK	2KOM/180CC
		SISNE GUME	GUMA
		KANTA	2KOM/30I, PROHRROM
		VAKUUM TANK	TOPLOCINČANI
		ELEKTRIČNI MOTOR	220V-50HZ, 3/4HP MONOFAZNI
		BENZINSKI MOTOR	HONDA GX120
		DIMENZIJE/TEŽINA	80X100X110CM / 110,00KG
KM04071 (ELEKTRIČNI MOTOR)		POKRETNA MUZILICA ZA ČETIRI KRAVE SA ČETIRI KANTE	
		VAKUUM PUMPA	ULJANA
KM04031 (MOTOR NA BENZIN)		KAPACITET PUMPE	750LT/H
		PULSATOR	4KOM/MEHANIČKI
		MLEKOSABIRNIK	4KOM/180CC
		SISNE GUME	GUMA
		KANTE	4KOM/30I, PROHRROM
		VAKUUM TANK	TOPLOCINČANI
		ELEKTRIČNI MOTOR	220V-50HZ, 3HP MONOFAZNI
		BENZINSKI MOTOR	HONDA GX120
		DIMENZIJE/TEŽINA	80X140X120 / 150,00KG



MUZILICE

MLEKOSABIRNIK 180CC - SISNE GUME-STANDARD GUMA

KP01050		RADNA POSUDA OD 25 L ZA KRAVE-KOMPLET	
		VAKUUM PUMPA	OPCIONALNO
		PULSATOR	1KOM/MEHANIČKI
		MLJEKOSABIRNIK	1KOM/180CC
		SISNE GUME	GUMA
		KANTA	1KOM/30l, PROHROM
		DIMENZIJE/TEŽINA	38X38X68 / 13,00KG
KP01053		RADNA POSUDA OD 30 L ZA KRAVE-KOMPLET	
		VAKUUM PUMPA	OPCIONALNO
		PULSATOR	1KOM/MEHANIČKI
		MLJEKOSABIRNIK	1KOM/180CC
		SISNE GUME	GUMA
		KANTA	1KOM/30l, PROHROM
		DIMENZIJE/TEŽINA	38X38X68 / 13,00KG







FIKSNA JEDINICA SA SUHOM VAKUUM PUMPOM

KM04010		FIKSNA JEDINICA ZA MUŽU (BEZ KANTE)	
		VAKUUM PUMPA	SUHA
		KAPACITET PUMPE	185LT/H
		MLJEKOSABIRNIK/SISNE GUME	OPCIONALNO
		KANTA/PULSATOR	OPCIONALNO
		VAKUUM TANK	TOPLOCINČANI
		ELEKTRIČNI MOTOR	220V-50HZ, 3/4HP MONOFAZNI
		DIMENZIJE/TEŽINA	40X65X90 / 40,00KG

FIKSNA JEDINICA SA ULJNOM VAKUUM PUMPOM

KM04040		FIKSNA JEDINICA ZA MUŽU (BEZ KANTE)	
		VAKUUM PUMPA	ULJNA
		KAPACITET PUMPE	200LT/H
		MLJEKOSABIRNIK/SISNE GUME	OPCIONALNO
		KANTA/PULSATOR	OPCIONALNO
		VAKUUM TANK	TOPLOCINČANI
		ELEKTRIČNI MOTOR	220V-50HZ, 3/4HP MONOFAZNI
		DIMENZIJE/TEŽINA	40X65X90 / 40,00KG
KM05027		FIKSNA JEDINICA SA VAKUM PUMPA OD 350 L	
		VAKUUM PUMPA	ULJNA
		KAPACITET PUMPE	350 LT/H
		PULSATOR	1KOM/MEHANIČKI
		MLJEKOSABIRNIK	1KOM/180CC
		SISNE GUME	OPCIONALNO
		KANTA	OPCIONALNO
		VAKUUM TANK	TOPLOCINČANI
		ELEKTRIČNI MOTOR	220V-50HZ, 1.5 HP MONOFAZNI
		TEŽINA	45,00KG
KM05027		FIKSNA JEDINICA SA VAKUM PUMPA OD 350 L KOMPLET	
		VAKUUM PUMPA	ULJNA
		KAPACITET PUMPE	350 LT/H
		PULSATOR	1KOM/MEHANIČKI
		MLJEKOSABIRNIK	1KOM/180CC
		SISNE GUME	OPCIONALNO
		KANTA	OPCIONALNO
		VAKUUM TANK	TOPLOCINČANI
		ELEKTRIČNI MOTOR	220V-50HZ, 1.5 HP MONOFAZNI
		TEŽINA	48,00KG

**MUZILICE ZA KOZE I OVCE****MLJEKOSABIRNIK 120CC - SILIKONSKE SISNE GUME****POKRETNE MUZILICE-SUHA VAKUUM PUMPA**







KM01032 (OVCE)		CYK MUZILICA ZA DVA GRILA SA JEDNOM KANTOM	
		VAKUUM PUMPA	SUHA
KM01036 (KOZE)		KAPACITET PUMPE	185LT/H
		PULSATOR	1KOM/MEHANIČKI
KM02072 (OVCE)		MLJEKOSABIRNIK	2KOM/120CC
		SISNE GUME	SILIKON
KM01050 (KOZE)		KANTA	1KOM/30I, PROHROM
		VAKUUM TANK	UNUTAR CIJEVI ŠASIJE
KM01012 (OVCE)		ELEKTRIČNI MOTOR	220V-50HZ, 3/4HP MONOFAZNI
		DIMENZIJE/TEŽINA	55X70X90CM / 47,00KG
KM01035 (KOZE)		MUZILICA ZA DVA GRILA SA JEDNOM KANTOM	
		VAKUUM PUMPA	SUHA
KM01032 (OVCE)		KAPACITET PUMPE	185LT/H
		PULSATOR	1KOM/MEHANIČKI
KM01036 (KOZE)		MLJEKOSABIRNIK	2KOM/120CC
		SISNE GUME	SILIKON
KM01032 (OVCE)		KANTA	1KOM/30I, PROHROM
		VAKUUM TANK	UNUTAR CIJEVI ŠASIJE
KM01036 (KOZE)		ELEKTRIČNI MOTOR	220V-50HZ, 3/4HP MONOFAZNI
		DIMENZIJE/TEŽINA	55X70X90CM / 47,00KG
DODATNI ELEMENTI			
VAKUUM PUMPA 350 LITARA			
TRECI POMOCNI TOČAK			
PAKET ZA DEZINFEKCIJU I ODRZAVANJE			



MUZILICE ZA KOZE I OVCE

MLEKOSABIRNIK 120CC - SILIKONSKE SISNE GUME

POKRETNE MUZILICE -ULJNA VAKUUM PUMPA

KM01042 (OVCE)		CYK MUZILICA ZA DVA GRILA I JEDNOM KANTOM	
		VAKUUM PUMPA	ULJNA
KM01039 (KOZE)		KAPACITET PUMPE	200LT/H
		PULSATOR	1KOM/MEHANIČKI
KM02082 (OVCE)		MLJEKOSABIRNIK	2KOM/120CC
		SISNE GUME	SILIKON
KM01056 (KOZE)		KANTA	1KOM/30I, PROHROM
		VAKUUM PUMPA	UNUTAR CIJEVI ŠASIJE
KM01022 (OVCE))		ELKTRIČNI MOTOR	220V-50HZ, 3/4HP MONOFAZNI
		DIMENZIJE/TEŽINA	55X70X90CM / 47,00KG
KM01038 (KOZE)		MUZILICA ZA DVA GRILA I JEDNOM KANTOM	
		VAKUUM PUMPA	ULJANA
KM02042 (OVCE)		KAPACITET PUMPE	200LT/H
		PULSATOR	1KOM/MEHANIČKI
KM01057 (KOZE)		MLJEKOSABIRNIK	2KOM/120CC
		SISNE GUME	SILIKON
KM03042 (OVCE)		KANTA	1KOM/40I, PROHROM
		VAKUUM TANK	UNUTAR CIJEVI ŠASIJE
KM01047 (KOZE)		ELKTRIČNI MOTOR	220V-50HZ, 3/4HP MONOFAZNI
		DIMENZIJE/TEŽINA	60X90X100CM / 60,00KG
KM01047 (KOZE)		MUZILICA ZA ČETIRI GRILA SA JEDNOM KANTOM	
		VAKUUM PUMPA	ULJNA
KM01047 (KOZE)		KAPACITET PUMPE	350 LT/H
		PULSATOR	2KOM/MEHANIČKI
KM01047 (KOZE)		MLJEKOSABIRNIK	4KOM/120CC
		SISNE GUME	SILIKON
KM01047 (KOZE)		KANTA	1KOM/40I, PROHROM
		VAKUUM TANK	TOPLOCINČANI
KM01047 (KOZE)		ELKTRIČNI MOTOR	220V-50HZ, 3/4HP MONOFAZNI
		DIMENZIJE/TEŽINA	60X90X110CM / 70,00KG
KM01047 (KOZE)		MUZILICA ZA ČETIRI GRILA SA DVIJE KANTE	
		VAKUUM PUMPA	ULJNA
KM01047 (KOZE)		KAPACITET PUMPE	350 LT/H
		PULSATOR	2KOM/MEHANIČKI
KM01047 (KOZE)		MLJEKOSABIRNIK	4KOM/120CC
		SISNE GUME	SILIKON
KM01047 (KOZE)		KANTA	2KOM/30I, PROHROM
		VAKUUM TANK	TOPLOCINČANI
KM01047 (KOZE)		ELKTRIČNI MOTOR	220V-50HZ, 3/4HP MONOFAZNI
		DIMENZIJE/TEŽINA	80X100X110CM / 80,00KG



MUZILICE ZA KOZE I OVCE

MLEKOSABIRNIK 120CC - SILIKONSKE SISNE GUME

POKRETNE MUZILICE -ULJNA VAKUUM PUMPA

KM04072 KOZE I OVCE SA ELEKTRIČNIM MOTOROM		MUZILICA ZA ČETIRI GRILA I DVE KANTE	
		VAKUUM PUMPA	ULJNA
KM04032 KOZE I OVCE SA BENZINSKIM MOTOROM		KAPACITET PUMPE	750LT/H
		PULSATOR	2KOM/MEHANIČKI
		MLJEKOSABIRNIK	4KOM/120CC
		SISNE GUME	SILIKON
		KANTA	2KOM/30l, PROHROM
		VAKUUM TANKA	TOPLOCINČANI
		ELEKTRIČNI MOTOR	220V-50HZ, 3HP MONOFAZNI
		BENZINSKI MOTOR	HONDA GX120
		DIMENZIJE/TEŽINA	80X140X120CM / 150,00KG

POKRETNE MUZILICE -ULJNA VAKUUM PUMPA

KP01054 (OVCE)		RADNA POSUDA ZA KOZE SA DVE MUZNE JEDINICE	
KP01045 (KOZE)		VAKUUM PUMPA	NEMA
		PULSATOR	1KOM/MEHANIČKI
		MLJEKOSABIRNIK	2KOM/120CC
		SISNE GUME	SILIKON
		KANTA	1KOM/30l, PROHROM
		DIMENZIJE/TEŽINA	38X38X68 / 14,00KG
KM04045 (OVCE)		FIKSNA JEDINICA ZA MUŽU SA JEDNOM RADNOM POSUDOM	
KM01063 (KOZE)		VAKUUM PUMPA	ULJNA
		KAPACITET PUMPE	200LT/H
		PULSATOR	1KOM/MEHANIČKI
		MLEKOSABIRNIK	2KOM/120CC
		SISNE GUME	SILIKON
		KANTA	1KOM/30l, PROHROM
		VAKUUM TANKA	TOPLOCINČANI
		ELEKTRIČNI MOTOR	220V-50HZ, 3/4HP MONOFAZNI
		TEŽINA	54,00KG
KM04046 (OVCE)		FIKSNA JEDINICA ZA MUŽU SA DVE RADNE POSUDE	
KM01062 (KOZE)		VAKUUM PUMPA	ULJNA
		KAPACITET PUMPE	200LT/H
		PULSATOR	2KOM/MEHANIČKI
		MLJEKOSABIRNIK	4KOM/120CC
		SISNE GUME	SILIKON
		KANTA	1KOM/40l, PROHROM
		VAKUUM TANKA	TOPLOCINČANI
		ELEKTRIČNI MOTOR	220V-50HZ, 3/4HP MONOFAZNI
		TEŽINA	68,00KG

FIKSNA JEDINICA ZA MUŽU SA SUHOM VAKUUM PUMPOM

KM04045 (OVCE)		FIKSNA JEDINICA ZA MUŽU SA JEDNOM RADNOM POSUDOM	
KM01063 (KOZE)		VAKUUM PUMPA	SUHA
		KAPACITET PUMPE	185LT/H
		PULSATOR	1KOM/MEHANIČKI
		MLJEKOSABIRNIK	2KOM/120CC
		SISNE GUME	SILIKON
		KANTA	1KOM/30l, PROHROM
		VAKUUM TANKA	TOPLOCINČANI
		ELEKTRIČNI MOTOR	220V-50HZ, 3/4HP MONOFAZNI
		TEŽINA	54,00KG



MUZILICE SA ELEKTRONSKIM PULSATORIMA

NOVO

POKRETNE MUZILICE-ULJNA VAKUUM PUMPA

KM01085
(180CC
MLJEKO
SABIRNIK)



KM01086
(240CC
MLJEKO
SABIRNIK))

MUZILICA ZA JEDNU KRAVU SA JEDNOM KANTOM

VAKUUM PUMPA	ULJNA	
KAPACITET PUMPE	200LT/H	
PULSATOR	1KOM	
MLJEKOSABIRNIK	1KOM/180CC	1KOM/240CC
SISNE GUME	GUMA	SILIKON
KANTA	1KOM/30l, PROHROM	
VAKUUM TANK	TOPLOCINČANI	
ELEKTRIČNI MOTOR	220V-50HZ, 3/4HP MONOFAZNI	
DIMENZIJE/TEŽINA	55X70X90CM / 47,00KG	

KM02044
(180CC
MLJEKO
SABIRNIK))



KM02050
(240CC
MLJEKO
SABIRNIK))

MUZILICA ZA DVIJE KRAVE SA JEDNOM KANTOM

VAKUUM PUMPA	ULJNA	
KAPACITET PUMPE	200LT/H	
PULSATOR	2KOM	
MLJEKOSABIRNIK	1KOM/180CC	1KOM/240CC
SISNE GUME	GUMA	SILIKON
KANTA	1KOM/40l, PROHROM	
VAKUUM TANK	TOPLOCINČANI	
ELEKTRIČNI MOTOR	220V-50HZ, 3/4HP MONOFAZNI	
DIMENZIJE/TEŽINA	55X70X100CM / 58,00KG	

KM03020
(180CC
MLJEKO
SABIRNIK))



KM03024
(240CC
MLJEKO
SABIRNIK))

MUZILICA ZA DVIJE KRAVE SA DVIJE KANTE

VAKUUM TANK	ULJNA	
KAPACITET PUMPE	200LT/H	
PULSATOR	1KOM	
MLJEKOSABIRNIK	1KOM/180CC	1KOM/240CC
SISNE GUME	GUMA	SILIKON
KANTA	1KOM/30l, PROHROM	
VAKUUM TANK	TOPLOCINČANI	
ELEKTRIČNI MOTOR	220V-50HZ, 3/4HP MONOFAZNI	
DIMENZIJE/TEŽINA	60X90X100CM / 60,00KG	



POKRETNO IZMUZIŠTE



POKRETNO IZMUZIŠTE X 6		
MR01301	POKRETNO IZMUZIŠTE X 6 (MEHANIČKI PULSATORI)	
MR01304	POKRETNO IZMUZIŠTE X 6 (ELEKTRONSKI PULSATORI)	
MR01305	POKRETNO IZMUZIŠTE X 6 (ELEKTRONSKI PULSATORI + 200LT SABIRNIK MLJEKA BEZ HLADJENJA)	
MR01312	POKRETNO IZMUZIŠTE X 6 (ELEKTRONSKI PULSATORI I AUTOMATSKI MERAČI)	

POKRETNO IZMUZIŠTE X 8		
MR01300	POKRETNO IZMUZIŠTE X 8 (MEHANIČKI PULSATORI)	
MR01323	POKRETNO IZMUZIŠTE X 8 (ELEKTRONSKI PULSATORI)	
MR01326	POKRETNO IZMUZIŠTE X 8 (ELEKTRONSKI PULSATORI + 200LT SABIRNIK MLJEKA BEZ HLADJENJA)	
MR01328	POKRETNO IZMUZIŠTE X 8 (ELEKTRONSKI PULSATORI I AUTOMATSKI MERAČI)	



KANTE ZA MLJEKO



PROHROMSKE KANTE ZA NOŠENJE 21Ø

KOD	KAPACITETA	PREČNIK „D,, U cm	PREČNIK „d,, U cm	VISINA „H,,	TEŽINA U kg
KP02083	20 LT	34	21	34	4,2
KP02087	25 LT	34	21	39	4,7
KP02091	30 LT	34	21	47	5,1
KP02094	40 LT	34	21	56	5,9
KP02096	50 LT	34	21	66	6,8





KANTE ZA MLIJEKO

PROHROMSKE KANTE SA ZAKLJUČAVANJEM I PROHROMSKIM POKLOPCEM 21Ø

KOD	KAPACITE T	PREČNIK „D,, U cm	PREČNIK „d,, U cm	VISINA „H,,	TEŽINA U kg
KP02084	20 LT	34	21	35	4,9
KP02088	25 LT	34	21	44	5,4
KP02092	30 LT	34	21	50	5,7
KP02095	40 LT	34	21	60	6,6
KP02097	50 LT	34	21	60	7,4

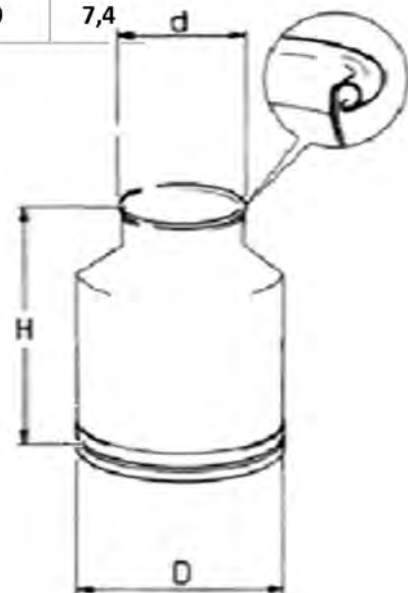



KANTE ZA MUŽU

KANTE ZA POKRETNE MUZILICE 18Ø



KOD	KAPACITE T	PREČNIK „D,, U cm	PREČNIK „d,, U cm	VISINA „H,,	TEŽINA U kg
KP02085	25 LT	34	18	44	4,7
KP02089	30 LT	34	18	50	5,0
KP02093	40 LT	34	18	60	5,9

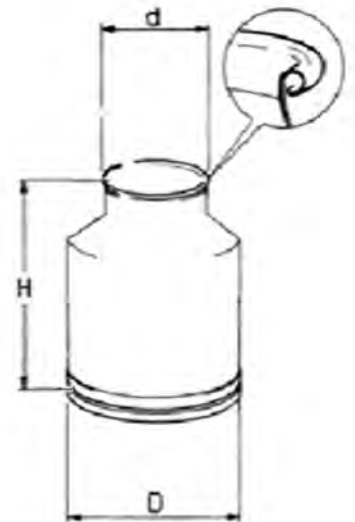

PROHROMSKE KANTE SA JEDNOM RUČICOM 18Ø



KOD	KAPACITE T	PREČNIK „D,, U cm	PREČNIK „d,, U cm	VISINA „H,,	TEŽINA U kg
KP02082	20 LT	34	18	38	4,4
KP02086	25 LT	34	18	44	4,9
KP02090	30 LT	34	18	50	5,2
KP02081	40 LT	34	18	60	6,1

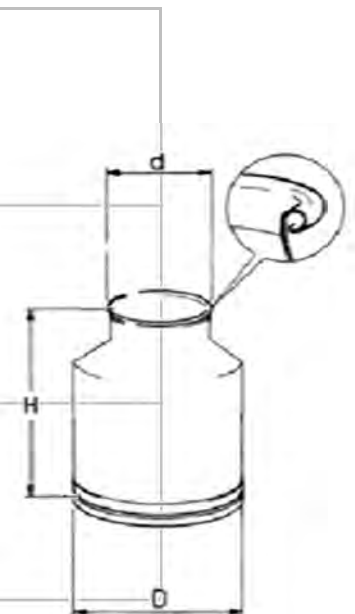



KANTE ZA MUŽU

KANTE OD POLIPROPILENA ZA POKRETNE MUZILICE



KOD	KAPACITE T	PREČNIK „D,, U cm	PREČNIK „d,, U cm	VISINA „H,,	TEŽINA U kg
KP01084	30 LT	34,7	18	52,5	4,55
KP01083	40 LT	34,7	21,5	63,0	5,0

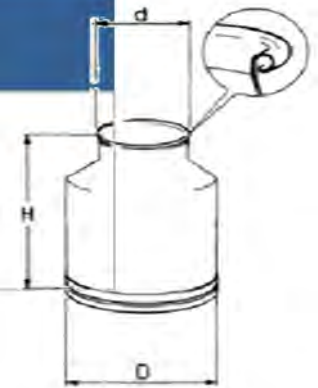

KANTE OD POLIPROPILENA ZA NOŠENJE MLEKA



KOD	KAPACITE T	PREČNIK „D,, U cm	PREČNIK „d,, U cm	VISINA „H,,	TEŽINA U kg
KP01055	30 LT	34,7	18	52,5	3,0
KP01082	40 LT	34,7	20,5	63,0	3,35

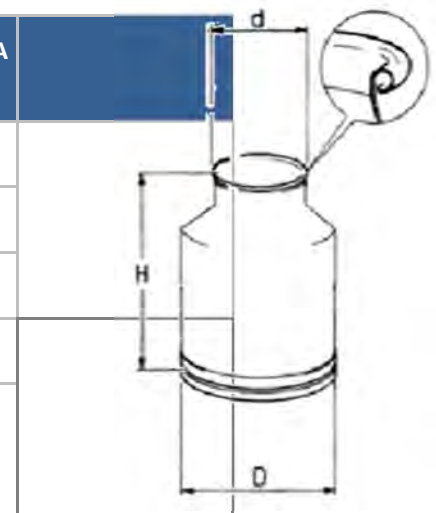



POKLOPCI ZA KANTE

KOD	OPIS	
KP02105		PROHROMSKI POKLOPAC ZA KANTE SA ZAKLJUČAVANJEM
MP02029		GUMENI POKLOPAC Ø18
MP02030		GUMENI POKLOPAC Ø21
MP02015		PLASTIČNI POKLOPAC SA DVE RUPE SA PROHROMSKE KANTE 18Ø 30lt
MP02016		PLASTIČNI POKLOPAC SATRI RUPE SA PROHROMSKE KANTE S 18Ø 40lt
MP02018		PLASTIČNI POKLOPAC SATRI RUPE SA PROHROMSKE KANTE S 21Ø 40lt
KP01017		PROHROMSKI POKLOPAC ZA RADNE POSUDE 18Ø 30lt
KP01009		PROHROMSKI POKLOPAC TIP ADAPTERA ZA RADNE POSUDE 18Ø 30lt
MP02027		DIHTUNG ZA PLASTIČNI POKLOPAC 21Ø 40lt
MP02025		DIHTUNG ZA PLASTIČNI POKLOPAC 18Ø 30lt
MP02028		DIHTUNG GUMA ZA PROHROMSKE POKLOPCE
KP01024		VAKUUM STOPER NA POKLOPCU
PP01093		LOPTICA ZA VAKUUM STOPER NA POKLOPCU
MP01096		POKLOPAC VAKUUM STOPERA NA POKLOPCU
MP01095		TIJELO VAKUUM STOPERA NA POKLOPCU



PRERADJIVAČI HRANE - MLIJEKA

KOD	OPIS
KM05084	 <p>KREM SPARATOR 140LT/H</p>
KM05017	 <p>ELEKTRIČNA BUČKALICA ZA IZDVAJANJE MASTI IZ MLIJEKA (PROHROM)</p>
	 <p>ELEKTRIČNA BUČKALICA ZA IZDVAJANJE MASTI IZ MLIJEKA (POLIPROPILEN)</p>
KM01078	 <p>ELEKTRIČNA BUČKALICA ZA IZDVAJANJE MASTI IZ MLIJEKA</p>
KM01079	 <p>ELEKTRIČNA BUČKALICA ZA IZDVAJANJE MASTI IZ MLIJEKA OD 55 LITARA</p>
KM01080	 <p>ELEKTRIČNA BUČKALICA ZA IZDVAJANJE MASTI IZ MLIJEKA OD 30 LITARA</p>
KM01076	 <p>SJECKALICA/PASIR ZA VOĆE I POVRĆE</p>



MAŠINE ZA ISHRANU ŽIVOTINJA

KOD	OPIS
KM05030	 <p>VEŠTAČKA MAMA ILI MAMA TAXI KAPACITETA 100 LITARA</p>
KM05019	 <p>MAMA TAXI ZA PRIPREMU MLIJEČNE ZAMENE SA PASTERIZATOROM OD 200LT (MLIJEKO / MLIJEKO U PRAHU / PASTERIZACIJA MLIJEKA)</p>
KM05032	 <p>STANDARDNI MODEL MAMA TAXI-A 200LT (MLIJEKO I MLIJEKO U PRAHU)</p>
KM01077	 <p>MAMA TAXI Z APRIPREMU I ODRŽAVANJE TEMPERATURE MLIJEKA OD 50 LITARA</p>
KM05033	 <p>VJEŠTAČKA MAMA ZA JAGNJIĆE I JARIĆE 200 LT (20 MESTA) OBIČNO MLIJEKO I MLIJEKO U PRAHU</p>
KM05036	









MAŠINE ZA PRIPREMU STOČNE HRANE

KOD	OPIS	
PP832300		MIKSER ZA PRIPREMU I DISTRIBUCIJU STOČNE HRANE OD 2m ³ - NA TRAKTORSKI POGON
PP832301		MIKSER ZA PRIPREMU I DISTRIBUCIJU STOČNE HRANE OD 2m ³ - NA ELEKTRIČNII POGON
		



MAŠINE ZA PRIPREMU STOČNE HRANE

KOD	OPIS	
KM05031	 <p>PRESA ZA ZRNA</p>	
KM05014	 <p>ELEKTRIČNI ČEKIČAR ZA ZRNO I KLIP (3HP)</p>	
KM05015	 <p>ELEKTRIČNI ČEKIČAR ZA ZRNO I KLIP (4HP)</p>	
KP02050	 <p>KOMPLETAN NOŽ ZA ČEKIČAR</p>	
YM01053	 <p>NOŽ ZA ČEKIČAR (POJEDINAČNO)</p>	
MP02053		SITO ZA ČEKIČAR Ø2
MP02054		SITO ZA ČEKIČAR Ø3
MP02055		SITO ZA ČEKIČAR Ø4
MP02056		SITO ZA ČEKIČAR Ø5
MP02057		SITO ZA ČEKIČAR Ø6
MP02058		SITO ZA ČEKIČAR Ø8



OPREMA ZA FARME

KOD		OPIS	
KM05018		AUTOMATSKA ČETKA ZA KRAVE (KOMPLET)	
PP02062		ELEKTRIČNI MOTOR SA REGULATOROM BRZINE ZA ATOMATSKU ČETKU ZA KRAVE (0.25KW-380V)	
PP08479		ELEKTRIČNA KARTICA ZA ČETKU	
PP02048		SENZOR ZA AUTOMATSKU ČETKU ZA KRAVE	
PP02051		ZAMENSKI SEGMENTI ČETKE (POJEDINAČNI) SE SASTOJI OD 4 SEGMENTA	ČETKA
PP04067		SPIRALNI PRIKLJUČNI KABEL 3X1,5 MM 220V	
KM05046		STATIČNA ČETKA ZA FIKSNU MONTAŽU	
KP03011		RUČNA KOLICA	
PP02052		TOČAK ZA RUČNA KOLICA	
KM01081		ELEKTRIČNI UREDJAJ ZA HVATANJE MUVA/KOMARACA.. (72x23,5x37cm)	
KF02011		VENTILATOR1100mm (1100x1100x280mm)	
KF02021		VENTILATOR 1380mm (1380x1380x280mm)	
KF02031		VENTILATOR 1530mm (1530x1530x280mm)	
KF02041		DRŽAČ VENTILATORA	



OPREMA ZA FARME

KOD	OPIS
MR09301	 <p>LIGA BOKS ZA KRAVE - POJEDINAČNI</p>
MR09349	 <p>KRMNA ZABRANA ZA KRAVE -POJEDINAČNA</p>
PP03120	 <p>GUMENI DUŠEK ZA KRAVE 180X110X200MM / 40KG</p>



FARM EQUIPMENTS

CODE	PRODUCT NAME	
		1 X 3 METALNA KONSTRUKCIJA ZA IZMUZIŠTE ZA KRAVE - RIBLJA KOST
		1 X 4 METALNA KONSTRUKCIJA ZA IZMUZIŠTE ZA KRAVE - RIBLJA KOST
		1 X 6 METALNA KONSTRUKCIJA ZA IZMUZIŠTE ZA KRAVE - RIBLJA KOST
		1 X 8 METALNA KONSTRUKCIJA ZA IZMUZIŠTE ZA KRAVE - RIBLJA KOST
		2 X 2 METALNA KONSTRUKCIJA ZA IZMUZIŠTE ZA KRAVE - RIBLJA KOST
		2 X 3 METALNA KONSTRUKCIJA ZA IZMUZIŠTE ZA KRAVE - RIBLJA KOST
		2 X 4 METALNA KONSTRUKCIJA ZA IZMUZIŠTE ZA KRAVE - RIBLJA KOST
		2 X 5 METALNA KONSTRUKCIJA ZA IZMUZIŠTE ZA KRAVE - RIBLJA KOST



FARM EQUIPMENTS

CODE	PRODUCT NAME
MR01059	 1X6 KRMNA ZABRANA (KOZE/OVCE) SA HRANILICOM
MR09158	1X6 KRMNA ZABRANA (KOZE/OVCE)
MR01060	 1X12 KRMNA ZABRANA (KOZE/OVCE) SA HRANILICOM
MR09159	1X 24 KRMNA ZABRANA (KOZE/OVCE)
MR01036	 1x12 KOMPLETNA PLATFORMA ZA KOZE



KUĆICA ZA TELAD



KOD	OPIS
MR06086	KOMPLETNA KUĆICA ZA TELAD SA OGRADOMI OSTALIM ELEMENTIMA
MR06082	PLASTIČNA KUĆICA (122X220X135) (45 KG.)
MR06088	POCINČANA OGRADA
PP01002	PLASTIČNE POSUDE ZA HRANU/VODU
YD01001	PLASTIČNA KOFA SA CUCLOM

KONSTRUKCIJA ZA SJEČU PAPAKA



KOD	OPIS
KM05034	KOMPLETNA KONSTRUKCIJA ZA SJEČU PAPAKA
KM05038	KONSTRUKCIJA ZA SJEČU PAPAKA SA VAGOM
KM05047	HIDRAULIČNA KONSTRUKCIJA ZA SJEČU PAPAKA KOMPLETNA
KM05048	HIDRAULIČNA KONSTRUKCIJA ZA SJEČU PAPAKA KOMPLETNA SA VAGOM



ELEKTRIČNA PASTIRICA

KOD	OPIS
YD03001	 NAPAJANJE ZA ELEKTRIČNU PASTIRICU FLASH 1000 (15 KM)
YD03002	 NAPAJANJE ZA ELEKTRIČNU PASTIRICU FLASH 2000 (30 KM)
YD03003	 ŽICA ZA ELEKTRIČNU PASTIRICU 2MM INOX (250 M) (HEM250)
YD03004	 ŽICA ZA ELEKTRIČNU PASTIRICU 3 MM INOX (250 M) (FE6-250)
YD03005	 ŽICA ZA ELEKTRIČNU PASTIRICU 2 MM INOX (500 M) (HEM500)
YD03006	 ELEMENTI ELEKTRIČNE PASTIRICE
YD03012	 IZOLOVANI STUB ZA ELEKTRIČNU PASTIRICU (PIQ150B)



OPREMA ZA TELAD

KOD		OPIS
YD01001		PLASTIČNA KOFA SA CUCLOM ZA TELAD
YD01003		PLASTIČNA KOFA SA 5 CUCLI ZA JAGNIČE/JARIČE
MR06091		BOČICA SA CUCLOM ZA TELAD
KP01003		POSUDA ZA DEZINFEKCIJU VIMENA
YD01006		SISALJKA ZA KOFU ZA TELAD
PP08182		SISALJKA ZA BOČICU ZA TELAD
YD01008		SISALJKA ZA JAGNIČE/JARIČE
YD01009		VENTIL ZA SISALJKE ZA JAGNIČE I TELAD
PP04982		ZAŠTITA OD UDARACA (RITULJA)
PP04983		PREVENTER PROTIV SISANJA



POJILICE

KOD	OPIS
KP01035	 AUTOMATSKA PLASTIČNA POJILICA OD 3 LITRE
KP01070	 AUTOMATSKA PROHROMSKA POJILICA OD 4 LITRE
KP01098	 POJILICA OD LIVENOG GVOŽDJA OD 3 LITRE
KP03015	 AUTOMATSKA PLASTIČNA POJILICA OD 4 LITRE
KP03016	 DUPLA AUTOMATSKA PLASTIČNA POJILICA OD 8 LITARA
KP03017	 PROTIV-SMRZAVAJUĆA AUTOMATSKA POJILICA OD 40 LITARA
KP03019	 PROTIV-SMRZAVAJUĆA AUTOMATSKA POJILICA OD 80 LITARA
KP03018	 PROTIV-SMRZAVAJUĆA AUTOMATSKA POJILICA OD 110 LITARA
KP01090	 PROHROMSKA POJILICA, TIP VALOVA, 150 LITARA - BEZ GREJAČA
KP01091	 PROHROMSKA POJILICA, TIP VALOVA, 240 LITARA - BEZ GREJAČA
KP03038	 PLOVAK ZA POJILICU
PP02098	 PLOVAK ZA POJILICU TIP VALOVA
KP02007	 PROHROMSKA POJILICA, TIP VALOVA, 100 LITARA - BEZ GREJAČA
	 PROHROMSKA POJILICA, TIP VALOVA, 140 LITARA - BEZ GREJAČA



PLOČICE ZA VAKUUM PUMPE

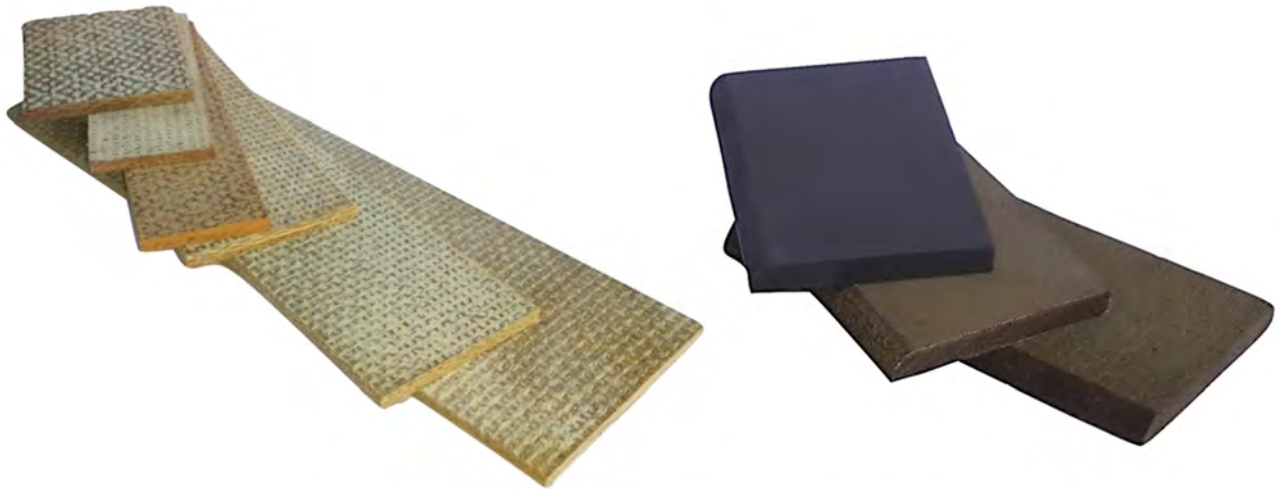

KOD	OPIS
PP01013	GRAFITNE PLOČICE 185LT ZA SUVE PUMPE 70X46X5.95MM
MP02071	FIBER PLOČICE 200LT ZA MONOBLOK PUMPE (ULJANE) 70X46X5.85MM
PP04872	FIBER PLOČICE 350LT ZA MONOBLOK PUMPE (ULJANE) 5,8X97,96X45MM
PP05109	FIBER PLOČICE 350LITARA 4,80X45X119MM
PP02353	FIBER PLOČICE 500LITARA 5,7X50X81,8MM
PP05104	FIBER PLOČICE 750LITARA 65X82X5,85MM
PP05105	FIBER PLOČICE 1000LITARA 50X164X5,85MM
PP05106	FIBER PLOČICE 1500LITARA 65X164X5,85MM
PP05107	FIBER PLOČICE 2200LITARA 65X248X5,85MM
PP05108	FIBER PLOČICE 3300LITARA 87X290X5,85MM



RESIVERSKI SET



KOD	OPIS
KP02101	RESIVER 50 LITARA SA POKLOPCEM I DIHTUNGOM
KP02102	RESIVER 60 LITARA SA POKLOPCEM I DIHTUNGOM
KP02103	RESIVER 80 LITARA SA POKLOPCEM I DIHTUNGOM
KP02104	RESIVER 100 LITARA SA POKLOPCEM I DIHTUNGOM

KOMPLET RESIVERSKI SET

KOD	OPIS
MR03042	KOMPLET RESIVERSKI SET 50 LITARA
MR03043	KOMPLET RESIVERSKI SET 60 LITARA
MR03044	KOMPLET RESIVERSKI SET 80 LITARA
MR03045	KOMPLET RESIVERSKI SET 100 LITARA



SISTEMI ZA PRANJE



KOD	OPIS
MR03051	AUTOMATSKA MAŠINA ZA PRANJE ZA VAKUUM PUMPU 3300 LITARA SA ODVODNIM VENTILOM (TOUCH SCREEN)
KP05052	AUTOMATSKA MAŠINA ZA PRANJE ZA VAKUUM PUMPU 3300 LITARA SA ODVODNIM VENTILOM
KP05051	AUTOMATSKA MAŠINA ZA PRANJE ZA VAKUUM PUMPU 2200 LITARA SA ODVODNIM VENTILOM
KP05050	AUTOMATSKA MAŠINA ZA PRANJE ZA VAKUUM PUMPU 1500 LITARA SA ODVODNIM VENTILOM
KP05057	MINI AUTOMATSKA MAŠINA ZA PRANJE
MR08013	BAZEN ZA MAŠINU ZA PRANJE 128 LITARA SA SVIM KONEKCIJAMA (BEZ ODVODNOG VENTILA)
MR05047	DOZIRNA PUMPA ZA AUTOMATSKU MAŠINU ZA PRANJE
MR05037	PUMPA ZA DOZIRANJE ZA AUTOMATSKU MAŠINU ZA PRANJE
MR05036	GUMA PUMPE ZA AUTOMATSKU MAŠINU ZA PRANJE
MR05108	CJEVČICE ZA BAZU I KISELINU 5*8mm
MR03055	SPIRALNO CREVO
MR05041	ELEKTRO VENTIL 1/4" 220V
MR03034	TRANSPARENTNO MLIJEČNO CREVI SA INOKS ŽICOM UNUTRA Ø38MM



JEDINICE ZA PRANJE



KOD	OPIS	
MR03063	PLASTIČNA Y RAČVA ZA JEDINICU ZA PRANJE	
KP02115	PROHROMSKA JEDINICA ZA PRANJE	
KP02114	PROHROMSKA JEDINICA ZA PRANJE - FIKSNA	
KP01057	PVC JEDINICA ZA PRANJE	
KP01076	JEDINICA ZA PRANJE SA GUMENIM ADAPTERIMA	
KOD	OPIS	
MP03064		UMETAK JEDINICE ZA PRANJE
MP03072		GUMENI UMETAK JEDINICE ZA PRANJE
MP03032		GUMENI ADAPTER ZA PRANJE



SISNE GUME



KOD		OPIS
MP02032		KRATKA SISNA GUMA ZA KRAVE 175MM
MP02033		SISNA GUMA ZA KRAVE DUGAČKA-ATANDARD 310MM
MP03083		SISNA GUMA ZA KRAVE DUGAČKA 330MM (YBK)
MP03084		SISNA GUMA ZA KRAVE DUGAČKA 300MM (YKK)
MP03086		SILIKONSKA SISNA GUMA ZA KRAVE DUGAČKA - STANDARD 310MM Ø10MM
MP03087		SILIKONSKA SISNA GUMA DUGAČKA ZA IZMUZIŠTA 310MM Ø11MM
MP03085		SILIKONSKA SISNA GUMA ZA KRAVE DUGAČKA 300MM (YKK)
MP05021		SILIKONSKA SISNA GUMA ZA OVCE 205MM
MP05022		SILIKONSKA SISNA GUMA ZA KOZE 242MM



DRŽAČI SISNIH GUMA

KOD		OPIS
MP05024		PLASTIČNI DRŽAČ ZA KRATKU SISNU GUMU
MP05023		PLASTIČNI DRŽAČ ZA DUŽU SISNU GUMU STANDARD
MP03088		PLASTIČNI DRŽAČ ZA NOVI MODEL DUGAČKE SISNE GUME
MP02040		PROHROMSKI DRŽAČ ZA KRATKU SISNU GUMU
KP01006		PROHROMSKI DRŽAČ ZA DUGAČKU SISNU GUMU - STANDARD
KP01027		PROHROMSKI DRŽAČ ZA NOVI MODEL DUGAČKE SISNE GUME
MP04088		DRŽAČ SISNE GUME ZA OVCE Ø24X109MM
MP04089		DRŽAČ SISNE GUME ZA KOZE Ø22,5X135MM



MUZNA JEDINICA 180cc















KOD	OPIS	
KP01051		MUZNA JEDINICA SA CRNIM SISNIM GUMAMA 180cc
KOD	REZERVNI DELOVI	
KP01012		PLASTIČNI-POLIKARBONAT- MLJEKOSABIRNIK 180cc
MP01043		POKLOPAC MLJEKOSABIRNIKA 180cc (PLASTIČNI)
MP01041		PODNOŽJE MLJEKOSABIRNIKA 180cc
MP02033		SISNA GUMA DUGAČKA 310mm
KP01032		KRATKO VAZDUŠNO CREVO 6,5X13mm
MP05023		DRŽAČ SISNIH GUMA
MP01044		DIHTUNG ZA POKLOPAC MLJEKOSABIRNIKA 180cc
MP01047		SPOLJNI VAKUUM STOPER 180cc
MP01046		UNUTRAŠNJI VAKUUM STOPER
MP01045		OSOVINA MLJEKOSABIRNIKA Ø6X38mm





MUZNA JEDINICA ZA KOZE/OVCE 120cc

KOD	OPIS	
KP01052		MUZNA JEDINICA ZA OVCE SA SILIKONSKIM SISNIM GUMAMA 120cc
KP01044		MUZNA JEDINICA ZA KOZE SA SILIKONSKIM SISNIM GUMAMA 120cc
KOD	OPIS	
KP02012		MLJEKOSABIRNIK ZA KOZE/OVCE 120cc
MP04081		POKLOPAC MLJEKOSABIRNIKA ZA KOZE/OVCE 120cc
MP04082		PODNOŽJE MLJEKOSABIRNIKA ZA KOZE/OVCE 120cc
MP04084		GUMICA ZA PODNOŽJE MLJEKOSABIRNIKA 120cc
MP04085		GUMICA ZA OSOVINU MLJEKOSABIRNIKA 120cc
SM01069		GALVANIZOVANI ŠARAF
MP04083		OSOVINA MLEKOSABIRNIKA 120cc
MP05021		SILIKONSKA SISNA GUMA ZA OVCE 205mm
MP05022		SILIKONSKA SISNA GUMA ZA KOZE 242mm
KP02026		KRATKO VAZDUŠNO CREVO ZA KOZE/OVCE
KP02025		KRATKO MLJEČNO CRIJEVO ZA KOZE/OVCE

**MUZNA JEDINICA ZA KOZE/OVCE 120CC**

KOD	OPIS
MP04088	 DRŽAČ SISNIE GUME ZA OVCE Ø24X109MM
MP04089	 DRŽAČ SISNE GUME ZA KOZE Ø22,5X135MM
PP02031	 PVC VENTILA ZA KOZE / OVCE
MP04086	 PLASTICNI DRZAC ZA CREVA
MP05025	 Y RAZVODNIK ZA MLECNA CREVA
MP05026	 Y RAZVODNIK ZA VAKUUM CREVA
MR03056	KAIS ZA KACENJE MUZNE JEDINICE
KP01068	 POLU-AUTOMATSKI VENTIL ZA KOZE OVCE
MP01123	 GORNJI DEO POLU-AUTOMATSKOG VENTILA
MP01124	 DONJI DEO POLU-AUTOMATSKOG VENTILA
MP01126	 ŠARAF VENTILA
MP01122	 SILIKONSKA MEMBRANA NA VENTILU ZA KOZE/OVCE
MP01121	 SILIKONSKA GUMICA VENTILA ZA KOZE/OVCE
MP01120	 SILIKONSKI VENTIL KOZE/ OVCE
MP01125	 DONJI ŠARAF VENTILA ZA KOZE/OVCE



KOD	OPIS
	MANURE SEPARATOR Separator sa kulom I pratecom elektrikom I elektronikom od 50 m ² na sat
	MANURE PUMP Pumpa za osoku sa pratecim elementima I prikljucima za separator
	MANURE MIXER Mikser za septicku jamu do 8000 m ² kapaciteta sa pratecom opremom za separator
	SKREPER SA PRATECIM ELEMENTIMA DO 100 m LANCA / UKUPNO I DVIJE DASKE OD 2,3 DO 3,5 m



INOKS POSUDE ZA HLADJENJE-LAKTOFRIZI



KOD		OPIS			
Laktofriz	Kapacitet	Broj mužnji		Napajanje 50Hz	
Tip	(litar)	2	4	(faza /V)	
RBV - 100	100	x	x	1/230	3/400
RBV - 150	150	x	x	x	
RBV - 200	200	x	x	x	
RBV - 300	300	x	x	x	
Laktofriz	Kapacitet	Broj mužnji		Napajanje 50Hz	
Tip	(litar)	2	4	(faza /V)	
RBH - 300	300	x	x	1/230	3/400
RBH - 400	400	x	x	x	
RBH - 500	500	x	x	x	
RBH - 650	650	x			x
RBH - 800	800	x			x
RBH - 1000	1000	x			x
RBH - 1200	1200	x			x
RBH - 1400	1400	x			x
RBH - 1600	1600	x			x
Laktofriz	Kapacitet	Broj mužnji		Napajanje 50Hz	
Tip	(litar)	2	4	(faza /V)	
RBK - 1200	1200	x	x	1/230	3/400
RBK - 1400	1400	x			x
RBK - 1600	1600	x			x
RBK - 2000	2000	x			x

**INOKS POSUDE ZA HLADJENJE-LAKTOFRIZI**

Laktofriz	Kapacitet	Broj mužnji	Napajanje 50Hz	
Tip	(litar)	2	(faza /V)	
			4 1/230	3/400
RBC – 1500	1500	x		x
RBC – 2000	2000	x		x
RBC – 2500	2500	x		x
RBC – 3000	3000	x		x
RBC – 4000	4000	x		x
RBC – 5000	5000	x		x
RBC – 6000	6000	x		x

Laktofriz	Kapacitet	Broj mužnji	Napajanje 50Hz	
Tip	(litar)	2	(faza /V)	
			4 1/230	3/400
RBP – 200	200	x	x	
RBP – 300	300	x	x	
RBP – 400	400	x	x	
RBP – 500	500	x		x



SIRARSKA OPREMA

OPIS



SIRARSKI KOTAO - PASTERIZATOR

Sirarski kotao / pasterizator kapaciteta po želji kupca.

Napajanje trofazno (380 V) za električnu izvedbu ili monofazno (230 V) za plinsku izvedbu.

Grijanje električnom energijom sa priključkom za boiler ili plinska izvedba.

Priključak za hlađenje vodom.

Mogućnost zagrijavanja – termička obrada mlijeka do 92 stupnja celzusa.

Automatska mješalica 30 okretaja u minuti

Automatska harfa.

Automatsko – digitalno reguliranje i upravljanje temperature

Upravljački ormarić sa frekventnim regulatorom broja okretaja reduktora.



PASTERIZATOR

Pasterizator kapaciteta po želji kupca.

Napajanje trofazno (380 V) za električnu izvedbu ili monofazno (230 V) za plinsku izvedbu.

Grijanje električnom energijom sa priključkom za boiler ili plinska izvedba.

Priključak za hlađenje vodom.

Mogućnost zagrijavanja – termička obrada mlijeka do 85 stupnja celzusa.

Automatska mješalica 30 okretaja u minuti

Ručna harfa.

Automatsko – digitalno reguliranje i upravljanje temperature

Upravljački ormarić.

Troplošni izolirani kotao.

Ispusni ventil DN 50 sa ručnim otvaranjem.

Materijal izrade: nehrđajući čelik W.Nr. 1.4301 (AISI 304).



PREDPREŠA ZA SIR

Poluautomatska ili automatska predpreša za sir kapaciteta po želji kupca.

Kapacitet se može rasporediti na više dijelova.

Materijal izrade: nehrđajući čelik W.Nr. 1.4301.

Na pokretnom postolju.

Pneumatsko potiskivanje sa mogućnošću regulacije pritiska.



SIRARSKA OPREMA

OPIS



PREŠA ZA SIR

Preša za sireve izrađena je od nehrđajućeg čelika W.Nr. 1.4301. Svako mjesto predviđeno je za prešanje 5 kalupa ili više (zavisno o veličini sira i želji kupca).

Prešanje se vrši s pneumatskim cilindrima od kojih je svaki promjera 50 mm i sa hodom od 300 mm.

Tijelo cilindra izrađeno je od eloksiranog aluminija glatke površine, dok je osovina cilindra izrađena od nehrđajućeg čelika.

Uključivanje i isključivanje preše za sireve vrši se pomoću zračnih ventila montiranih na preši.

Preša za sireve je na pokretnom postolju sa 2 pokretna i 2 fiksna kotača.

Pritisak preše se regulira preko regulatora pritiska montiranog na preši za sireve.

Postolje preše je konstruirano tako da se sva sirutka skuplja na jedno centralno mjesto od kojeg nadalje odvodi po želji



SIRARSKI STOL

Sirarski stol izrađen je od nehrđajućeg čelika W.Nr. 1.4301.

Sirarski stol može biti sa radnom plohom sa rubom visine 40 mm, sa ispustom, sa 1 policom ispod radne plohe,

na kotačima sa inox vilicama (1 pokretni sa kočnicom, 1 pokretni i 2 fiksna) ili po želji kupca



SIRARSKI SUDOPER

Sirarski sudoper izrađen je od nehrđajućeg čelika W.Nr. 1.4301.

Sudoper može biti sa 1, 2 ili 3 korita dimenzija po želji, sa policom, ormarićem za zaključavanje prostora ispod korita ili po želji kupca.

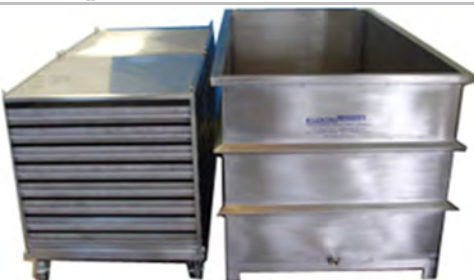

KADA ZA SALAMURU

Kada za salamurenje kapaciteta po želji kupca.

Materijal izrade: nehrđajući čelik W.Nr. 1.4401.

Na pokretnom ili stabilnom postolju.

Sa ili bez regulacije medija u kadi



Sistem za navodnjavanje

OPIS



Mini ventil nazubljeni 16x16



Mini ventil nazubljeni-umetak 16x16



Mini ventil nazubljeni-16x3/4 muški



Mini ventil umetak (za traku) 17x16



Mini ventil traka 17x17



Mini ventil traka-muški 17x3/4



Mini ventil nazubljeni prsten 17x16



Mini ventil prsten-umetak 17x16



Mini ventil prsten 17x17



T komad muški prsten 17x1/2x17



T komad muški traka 17x1/2x17



T komad umetak prsten 17x20x17



Nipl 16x16



Nipl 16x16



Kraj cijevi 16 mm



Sistem za navodnjavanje

OPIS



T komad nazubljeni 16x16x16



Koljeno 16x16



Držac cijevi dugi/kratki



Kapaljka 0-100 L/h



Kapaljka 0-70 L/h



Silikonska gumica - umetak 16mm



Ručna bušilica 16 mm



Ručna bušilica 3 mm



Aku nastavak 16 mm



PVC filter 32"/50"



Mrežica za filter



PVC ventil 1"/11/2"



Sistem za navodnjavanje

OPIS



Mini prskalica 2,8x18



3/4 prskalica



1" prskalica



Spojnica ženska
32x1"
50x11/2



Spojnica muška
32x1"
50x11/2



Poluspojnica 32x32
50x50x



T komad 50x50x5
32x32x32



Koljeno 50x50
32x32



Reducir spojnica
50x32



Koljeno žensko/muško
32x1"
50x11/2



T komad ženski/muški 32x3/4x32
50x11/2x50



Kraj cijevi 32mm
50 mm



Reducir T komad
50x32x50

Ventil (slavina) sa poluspojnicom
32x1"
50x11/2"



Obujmica 32x3/4
50x3/4





Sistem za navodnjavanje

OPIS



Polidrip crijevo za navodnjavanje 0,9 mm fi 16 x 33 cm

400m rola

Polidrip crijevo navodnjavanje 0,9 mm fi 16 x 20 cm

400m rola

Polidrip crijevo navodnjavanje 0,9 mm fi 16 bez kapaljki

400m rola



Protivgradne mreže

OPIS



Sistemi za protivgradnu zaštitu čine mreže koje su postavljene na noseće stubove i pričvršćene na noseće elemente za montažu.

Mrežama se mogu pokrivati zasadi malina, kupina, vinove loze, jabuka, bresaka na manjim ili većim površinama.





Pokriveni zasadi su potpuno zaštićeni od grada, jake kiše, vjetra ili snijega. U zavisnosti od gustine pletiva mreže postiže se zasjenčenost. Time se zasad štiti od nepovoljnog uticaja jakog sunca. Iskustva su pokazala da se primjenom ovih sistema dobijaju kvalitetniji plodovi i veći prinosi zasada i do 40%.



Protivgradne mreže

OPIS

Artikal	Težina g/m ²	Širina mreže m	Dužina mreže m	Visina rolne m	Boje	
Protivgradna mreža	30	1, 2, 3, 4, 5, 6	100, 200, 250, 333, 160	2→1, 3→1.5, 4→2, 5→2.5, 6→3	zelena	
Multi protivgradne mreže	45	2, 3, 4, 5, 6	100, 150	2→1, 3→1.5, 4→2, 5→2.5, 6→3	zelena	
Protivgradna mreža 2,6x4 3x7	53 51	1-5.2 1-5.2	600 600	2-3.8 2-3.8	crna	

Elementi za fiksiranje mreža



Kape

Kape za stubove drvene ili betonske sljedećih dimenzija: Fi 6, Fi 8, Fi 10 i Fi 14cm
Univerzalna kapa za stubove

Štipaljke

Štipaljke sa 2 tačke, štipaljke sa 2 tačke sa kukom, štipaljke sa 13 tačaka, štipaljke sa 16 tačaka sa kukom.



Kuke

Kuka C i S

Ankeri

PE ankeri za vezivanje

Vezice

Vezice za povezivanje

Štipaljka

Štipaljka za učvršćivanje

Zakačka

Zakačka za žice

